

ALFANO[®]

CHRONOMETRIC SYSTEM

M4 / M4GPS

A1003 + A1011 / A1003 + A1012



User's manual (EN)

This manual is adapted from **Firmware V2.2.0**

V.doc.07 / 28-01-2014

M4 / M4GPS

| | |
|--|-----------|
| Introduction | 4 |
| Installation | 5 |
| Power supply | 8 |
| Batteries | 8 |
| Switch ON / Switch OFF / Backlight | 9 |
| « WELCOME » page | 10 |
| The shortcuts | 10 |
| The most used symbols | 11 |
| Setup menu | |
| Setup | 12 |
| Power off | 12 |
| Bluetooth | 12 |
| Track | 13 |
| Hour/date | 13 |
| Pilot | 13 |
| LED | 13 |
| Display | 13 |
| BOX configuration & check of the sensors | 14 |
| The GPS reception (M4GPS) | 15 |
| Running time meters | 15 |
| Peak | 16 |
| RPM | 16 |
| Speed | 16 |
| Graphic settings | 17 |
| Frequency of sampling | 17 |
| Units | 17 |
| Languages | 17 |
| Parameters by default | 18 |
| GPS « ON/OFF » (M4GPS) | 18 |
| Update | 18 |
| BASIC mode (simplified working) | 19 |
| Tracks management | |
| Track management | 20 |
| Information | 20 |
| A) Creation of track : Magnetic / Infrared | 21 |
| B) Creation of track : GPS | 22 |
| C) Creation of track : Mag/IR + GPS | 24 |
| Import tracks from another M4/M4GPS, via Bluetooth | 28 |
| Starting a timing session and using your device on race | 29 |
| DATA (Menu) | |
| The Best, « Absolute » & « Last Session » | 30 |
| DATA | 30 |
| Tracks used | 30 |
| Data erasing | 30 |

| | |
|---|-----------|
| DATA | |
| Best Laps | 31 |
| Theoretical Lap | 32 |
| Sessions | 32 |
| Download | 34 |
| Meters of running time | 34 |
| Racing displays (Layouts) | 35 |
| BASIC mode | |
| Switch from FULL mode to BASIC mode | 38 |
| (Button 4), Switch on, Switch off, Bluetooth activation | 38 |
| (Button 1), DATA, erase data | 39 |
| (Button 2), Tracks | 40 |
| A) Creation of a track : Magnetic/Infrared | 40 |
| B) Creation of a track : GPS | 41 |
| (Button 3), SETUP (configuration) | 42 |
| RPM | 42 |
| Temperature | 43 |
| Display | 43 |
| Unit | 43 |
| Go back to FULL mode | 43 |
| Power supply : options & accessoires + consumption's board | 44 |
| VisualData2 | 46 |
| Update Firmware | 46 |
| Various | 47 |
| Memory | 47 |
| GPS | |
| GPS signal | 47 |
| Number of satellites | 47 |
| Date & hour | 47 |
| Warranty conditions | 48 |
| Modifications of products | 48 |
| Damage and responsibilities | 48 |
| Disposal | 48 |

Introduction

The pack M4 is composed of a display ADM model (medium) and of a box ABX4.

The pack M4GPS has the same display but a box ABX4GPS, this box is integrated with a GPS module that obtains the speed, track mapping and GPS timing.

The display (ADM) consists of a Bluetooth communication, 11 Leds, 4 pushing buttons, external size : 133.5x90x20mm, weight : 253gr.



The BOX (ABX4) : 4 entries, external size 85x88x54mm, weight : 165gr.

The BOX (ABX4GPS) : 4 entries, external size 85x88x54mm, weight : 177gr.

RED connector

With a Y cable « A2190 », possibility of connecting up to 2 temperature sensors (NTC+K) or a sensor of temperature (NTC) + a Lambda sensor

BLACK connector

BUS : Display



GREEN connector

Magnetic sensor or infrared (timing)

YELLOW connector

RPM, 2 types :
High tension or
Low tension PRW

The pack M4 / M4GPS is delivered with a magnetic sensor ref. A1301, an RPM sensor ref. A1601, a BUS cable ref. A3101 allowing the connection between the box and its display, a fixing support for the box, the batteries and an USB key Bluetooth to be connected to the computer for the downloads of your data and to make the updates (firmware) of your system.

Installation

Installation of the display « ADM »

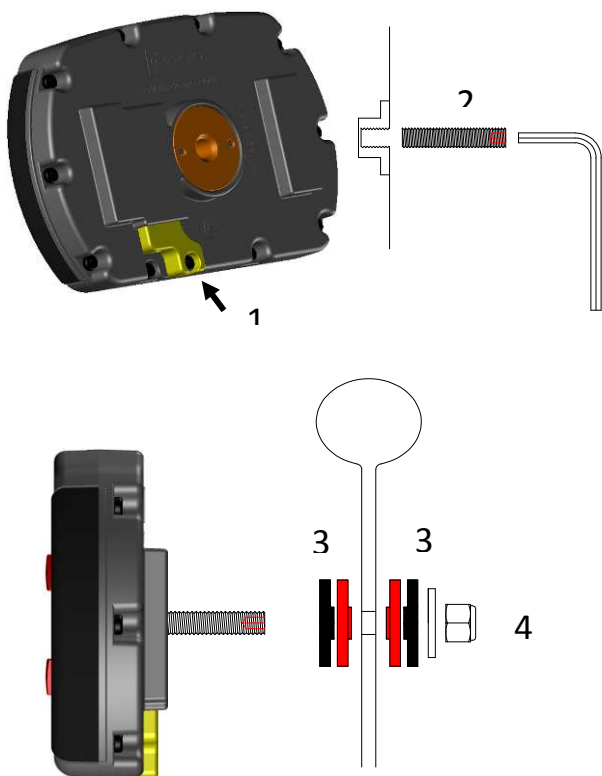

- 1) Insert and fix the connector of the BUS cable in its housing with the supplied screw.
- 2) Introduce the screw 8x40mm without head into the metallic part with a hexagonal key of 4mm by tightening it firmly.
- 3) Fix the display to the steering wheel by respecting the order of slices : red, black and that in metal.
- 4) Tighten the set with the autoblocking M8 metal nut.

Installation of « BOX4 »

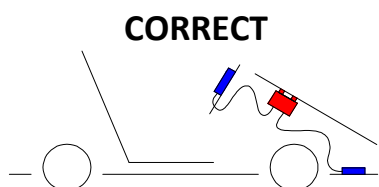

The BOX must be absolutely fixed below nassau panel, like this drawing.

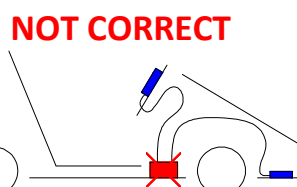

The BOX cannot be installed on the floor!

Go-kart :

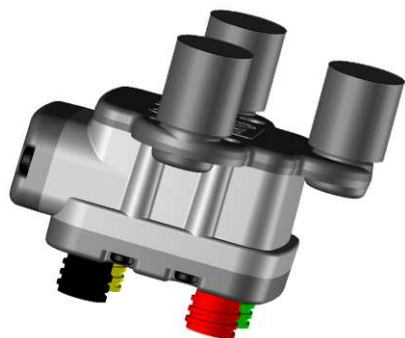

- 1) Drill 3 holes (+/-7mm) in nassau panel, use Box4 as template to draw holes.
- 2) Fix silentblocs to Box4 with the M6 autoblocking nuts.
- 3) Install Box4 below nassau panel (batteries' cover managed towards the driver) with the conical stainless screws and the plastic slices.

Installation of « BOX4GPS » ATTENTION when installing an onboard camera

CORRECT

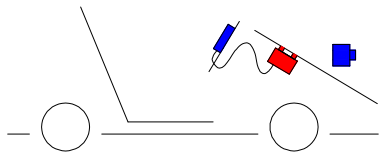

NOT CORRECT

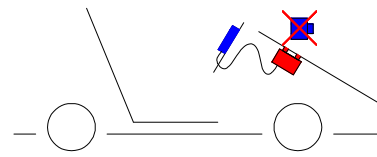

The BOX4GPS must be necessarily settled below dashboard panel so that the antenna is managed towards the sky, any object placed just over the box engenders a bad reception of the GPS signals, a camera or quite different electronic device stresses even more the disturbances of the GPS signal, these devices must be placed away from the box of minimum 30cm/12inch.

During an installation as above, the sensibility of the GPS signals decreases in more than 50 %. It engenders a bad catching of the timing data and an erroneous track mapping.

Installation of « RPM » sensor

CORRECT

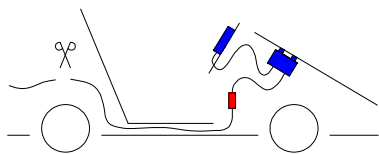

NOT CORRECT

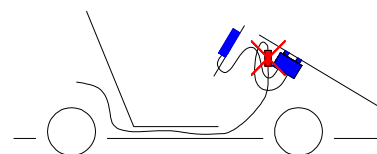

The RPM sensor case must be placed as far as possible from the box. The thin cable which links on the High-voltage cable of the ignition must be settled alone, the most distant possible of the other cables. If need be, cut the cable for a linear installation.

The module of the sensor RPM MUST NOT be installed near the BOX.

A bad installation pulling important electronic disturbances can cause a dysfunction, the extinction or the blocking of your ALFANO.

Use an anti-interferences hood



Internationally recognized to reduce the electromagnetic pollution

Some systems of ignition are very aggressive. Use then a hood of candle equipped with a resistance of 5kOhm for an optimal functioning of the system, while maintaining the performances of your engine.

Strongly recommended PRECAUTION : it prevents a dysfunction, the extinction or the blocking of your ALFANO.

Installation of the connectors

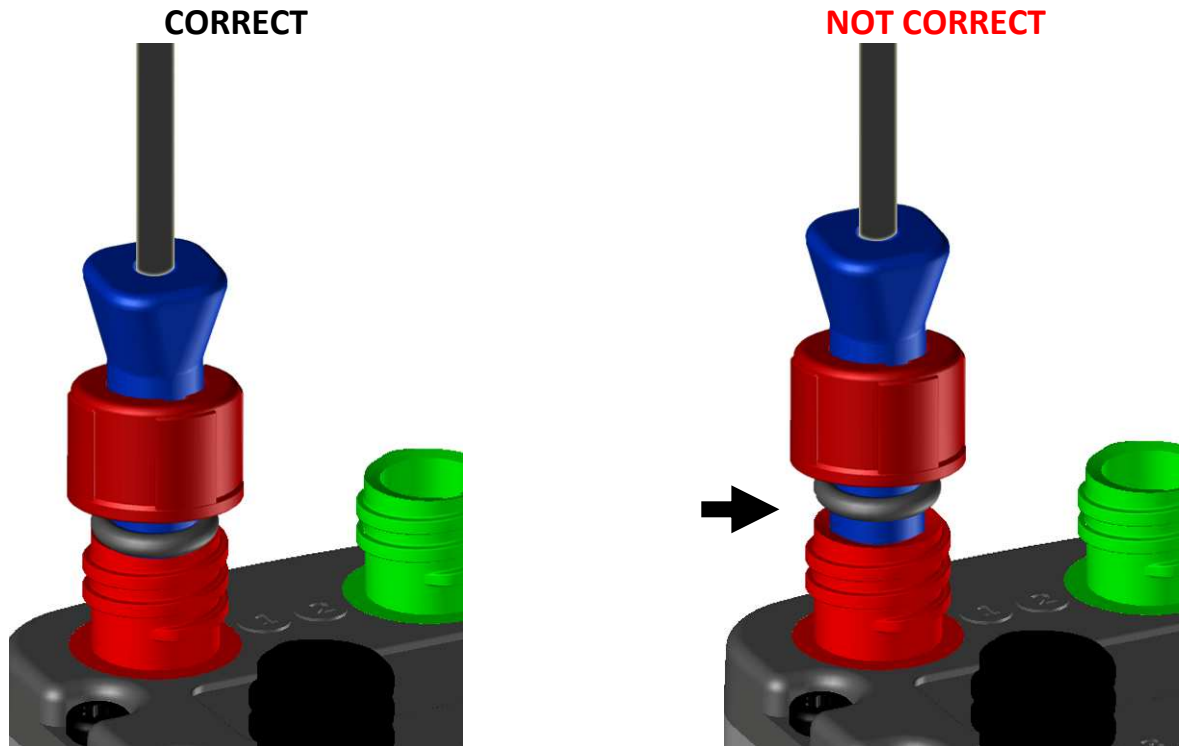

Introduce completely the male connector into its housing, the black rubber joint has to be against the female connector before tightening the nut.

This would pull a penetration of water and a bad electric contact, because during the tightening of the nut, the black joint dislodges of its location.

The screwdriver

Use a screwdriver of type Torx X20 to fix the batteries cover.



Power Supply

The M4/M4GPS is delivered with 2 batteries of type AA 1,5V. On the welcome page, you can check the batteries' life. When the power becomes too weak, a message appears :



When this message displays, M4/M4GPS goes automatically off after 10 seconds.

Notes :

The GPS module requires +/- 40% of the system's total energy to function.

The intensity of the backlight and the LEDs brightness intensity decrease the life of batteries.

Remark : Always check the batteries' life before beginning a long session. The consumption and speed of discharge depend on the quality and type of batteries, that's why it is strongly recommended to always check the batteries' life icon on the welcome page.

Batteries

The technology applied to our new systems requires larger battery consumption; battery quality is crucial ! There are 3 major types of AA batteries on the market.

Salines :

Salines are rarely used, they only have about a third of the energy of Alkaline batteries.

Alkalines :

Alkaline batteries are the best option.

Rechargeable :

Very good option, but the qualities from a brand to another are important. A bad brand loses its energy even with no use at about 1% a day. Furthermore, these batteries have a memory effect, if you recharge a battery which is half full while in use, you will not be able to use more than half of the stored energy, and the other half will be lost. There are very good rechargeable batteries that even with no use only losses 12% during a whole year and they don't have a memory effect, you can thus use all the energy, these batteries were used in our new systems with complete success.

Recommended examples of brands : SANYO Enellope XX and the UNIROSS Hydro, they are more expensive but will give a lot of satisfaction; you can recharge them minimum 500 times. They are used in Professional photography.



IMPORTANT WARNING



Always use quality and leading batteries.

Never leave piles in your device if this one is not used in 2 in 3 weeks which follow to avoid any casting of batteries on the electronics causing irreparable damage.

The guarantee does not work in case of casting of batteries.

Switch on / Switch off / Backlight

Switch on : press on the lower-right button (4).



Backlight :

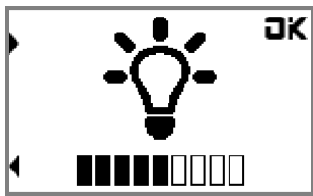
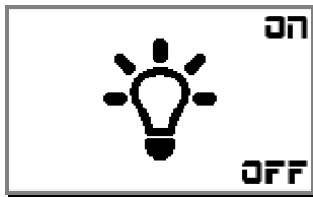

Depending on the setting on DISPLAY menu on SETUP, the device switches on as follows :

- « **OFF** » : the device switches on without backlight.
- « **MAN** » : the device suggests the backlight :
 - To activate : press on « **ON** », then, possibility of adjusting its bright power.
 - Not to activate it : press on « **OFF** » or nothing match 3 seconds.
- « **1-9** » : the device switches on automatically with backlight.

Then, the device goes back to « WELCOME » page.

Note : the consumption of the backlight decreases the autonomy of the batteries of +/-20 to 40 %.

Switch off : on « WELCOME » page, a **2 seconds** pressure on same button.



Automatic switch off :

the device switches off after having been inactive during a time which can be adjustable in SETUP menu Display, from 1 till 30 minutes.

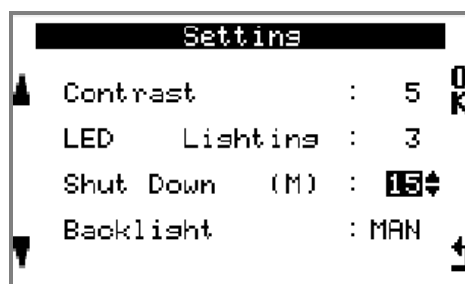

« WELCOME » page

The « WELCOME » page is the main window of the ALFANO. The menus of this window give access to the settings of the parameters « SETUP », to the visualization of « DATA », to the activation and to the putting with zero of « ENGINE METERS », to the choice of racing displays (LAYOUTS) and through shortcuts : direct access to data of last SESSION, activation or extinction of the backlight, activation of Bluetooth module, extinction of system.

• DATA
(Button 1)

Batteries life

• Engine meters
(Button 2)

Memory space

(Button 3)

• Setup

(Button 4)

- Switch on
- Racing displays « Layouts »
- Bluetooth activation
- Switch off

backlight activated

In « WELCOME » page, the temperatures **T1** (bigger, in the display's center) and **T2** (littler, above T1), display after 10 seconds of inactivity of buttons.

The shortcuts

Shortcuts allow to skim through several passages to reach directly a display or a wished option.

In « WELCOME » page :

- **1** second pressure on button 1 = direct access to the data of the last SESSION.

- **1** second pressure on button 3 = activate or deactivate the backlight.



- **1** second pressure on button 4 = activate the Bluetooth





- **2** second pressure on button 4 = extinction of the system



The most used symbols



- Buttons 1, 3 :
 - The arrows managed toward the left ◀ and the right ▶ allow to move from a menu to another one, in some cases, a long pressure allows a faster scrolling.
 - The arrows managed upward ▲ and downward ▼ allow to move from an option to another one, to modify numerical and alphabetical values, in certain cases, a long pressure allows a faster scrolling.
- Button 2 «  » :
 - allows to confirm a state and at the same time, in certain case, to move on the following option.
- Button 4 «  » :
 - allows to backtrack or to go out of a menu.

SETUP

In « WELCOME » page, press on SETUP :



Power off

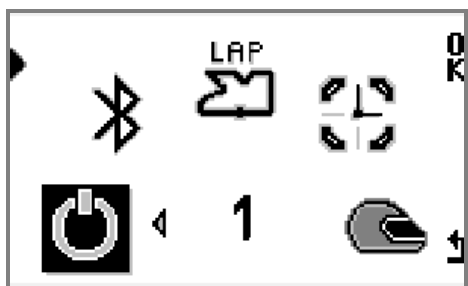

Press on «OK» to switch off the ALFANO.



Bluetooth



Personalize the personal code to protect your data during the connection (code by default « 000000 »). The name of the peripheral and the PIN code cannot be modified, they are unique for every device. **ATTENTION** : This window does not activate Bluetooth.



Tracks



This menu consists mainly in creating a list of « tracks » with their morphology, in magnetic or in GPS or both together. It will allow to avoid re-configuring the same track during its next use. See chapter «Tracks management», page 19



Hour/date

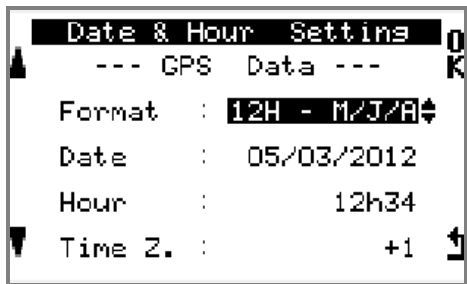

Settle :

- « M4 » the format of date and hour.
- « M4GPS » the format of date and the time zone, as the date and the hour are supplied by satellites with GMT, this information is thus visible only in the presence of these.

Note : for the M4, after the replacement of batteries, this window appears to the next starting up of the ALFANO, for the update.



Pilot

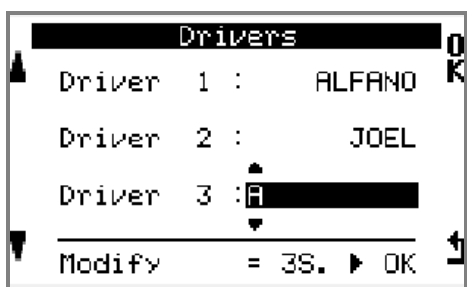

Possibility of editing up to 3 pilots' names. The chosen pilot will be associated with the SESSION of timing.

To choose a pilot : select him with left arrows, then press on «OK».

To modify the name of the pilot : 3 seconds pressure on «OK» on the name to be modified.



LEDs

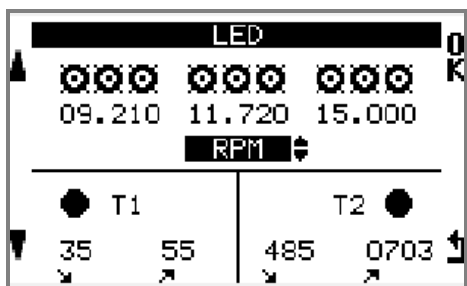

Settle thresholds :

- of the 9 leds (by group of 3), over the display for the **RPM / LAMBDA / T1 / T2,**
- of the 2 leds (level Low and level High), on left and on right of the display for **T1 / T2.**

Note : they will shut down when the moderate temperature will be between these two levels.



Display

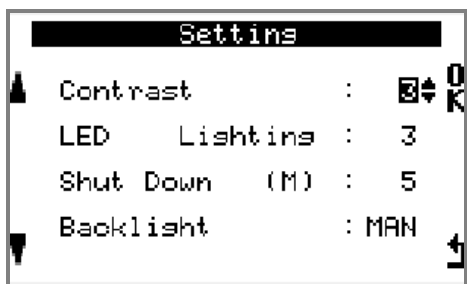

Settle :

- screen contrast,
- LEDs brightness,
- time for automatic extinction,
- Backlight :
 - « OFF » : the device switches on without.
 - « MAN » : the device suggests it.
 - « 1-9 » : the device switches on automatically with (Set its brightness power from 1 to 9).



M4GPS



M4

ABX4 / ABX4GPS



BOX (ABX4) with 4 entries as follows :

- 1 entry **BUS (Display)**
- 1 entry **RPM**
- 1 entry **Time (Magnetic/Infrared)**
- 1 entry for 1 or 2 **Temperatures (T1, T2)**

BOX (ABX4GPS) with 4 entries as follows :

- 1 entry **BUS (Display)**
- 1 entry **RPM**
- 1 entry **Time (Magnetic/Infrared)**
- 1 entry for 1 or 2 **Temperatures (T1, T2)**
- **GPS integrated**

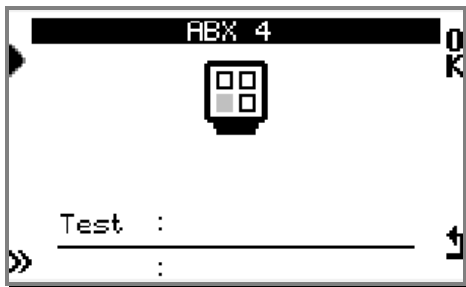

This menu consists in configuring and in checking the functioning of the sensors:

- Press on arrow to commute between entries of the BOX,
- Press on arrow to choose the sensor on the list
- Press on to settle and confirm,
- Press on to return behind.

● Entry 1 : « temperatures, T1-T2 » and Lambda

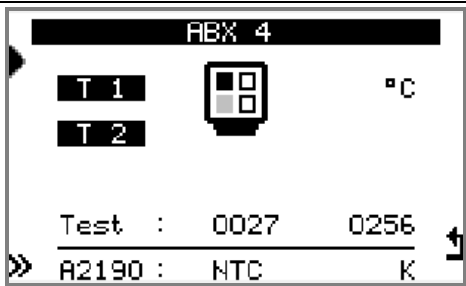

Possibility of connecting 2 sensors with the Y cable « A2190 ». Press on arrow to make your choice :

- **NTC**
- **K**
- **NTC+K**
- **NTC+Lambda**
- **Lambda.**

Test : The values of the sensors are readable on real time.

● Entry 2 : « timing »



Sensor for taking time

- **Magnetic / Infrared**



Test : approach a magnet to the magnetic sensor or activate the infrared transmitter in front of the receiver IR, « --- **OK** --- » has to display during a few seconds.

Entry 4 : « RPM »

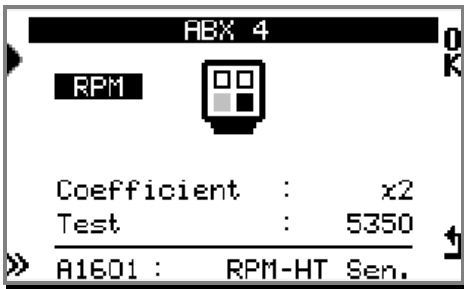

Press on arrow **»** to choose this sensor :

- **A1601** : RPM-HT (High tension)
- **A1606** : RPM-PWM (Low tension)

CAUTION: The A1601 is supplied in the package for Karting.



Press on « **OK** » to modify the coefficient of multiplication of the RPM, dependent on the type of engine :

- /4
- /2
- X1
- X2
- X4

Then, press again on « **OK** » to confirm.

Test : Launch the engine, the value RPM has to display

ATTENTION :

If the configuration of the sensor does not correspond in sensor installed, the reading will be ERRONEOUS or there will be NO READING.



The GPS reception (M4GPS)

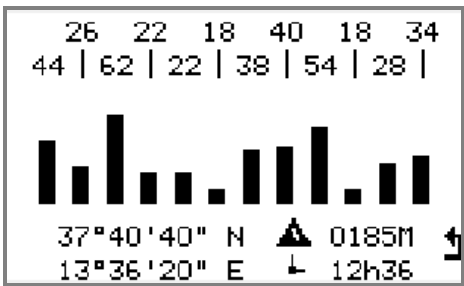

Check :

- the intensity of the satellites signals,
- the GPS coordinates in real time,
- the date and the hour in GMT,
- the height.



Running meters



Two available meters :

- the first one accumulates the **total time**,
- the second accumulates the **browsed distance**.

Press 1 second on « **OK** » to put back to zero the selected meter. Note : the latter is active in the presence of the speed.



Peak

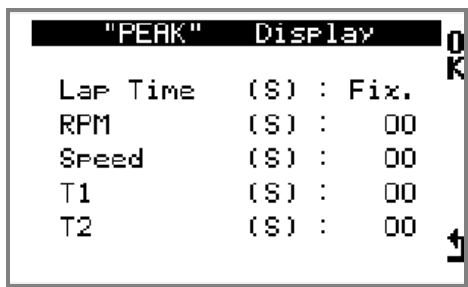

In race, in every detection of level change of the data between the down/up and the up/down of **RPM, SPEED, T1, T2**, the ALFANO allows to freeze these values in the screen during a scheduled lapse of time, this to have time to visualize them.

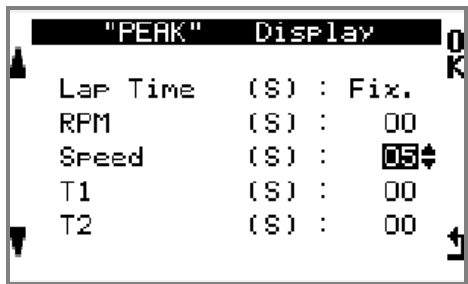

Settle :

- Laptime : -----> Fixe à 60 sec.
- RPM : -----> 0 à 60 sec.
- Speed : -----> 0 à 60 sec.
- Temperature T1 : -----> 0 à 60 sec.
- Temperature T2 : -----> 0 à 60 sec.



RPM

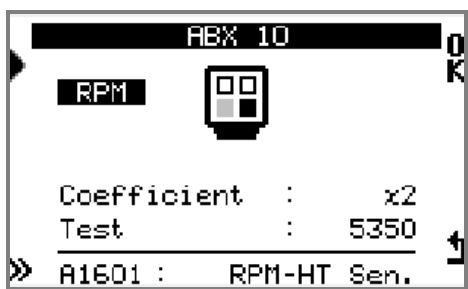

This menu is a direct access allowing to settle the parameters of the RPM.



Speed

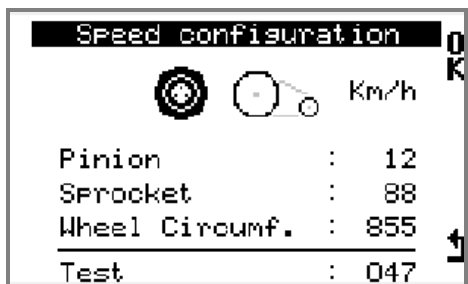

Settle :

- **OFF** : (no speed)
- **TRANSMISSION** : the speed obtains by introducing the number of teeth : of the driving pine nut and the crown, more the circumference of the back wheel. Attention : this method works only on vehicles with direct transmission, without gearbox.
- **GPS** : The speed will be got by GPS (M4GPS)



Graphic setting

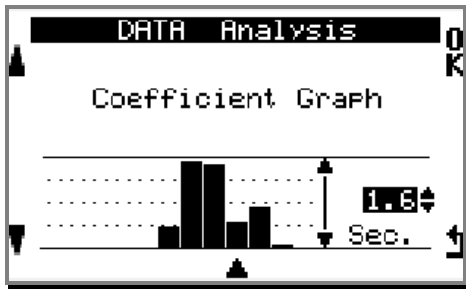

Settle :

The height of bars-graphs sized by time can be adjusted from 0.5 seconds till 10 seconds between the low level and the high level. This to observe at best the differences of time between every lap in the menu DATA.



Frequency of sampling

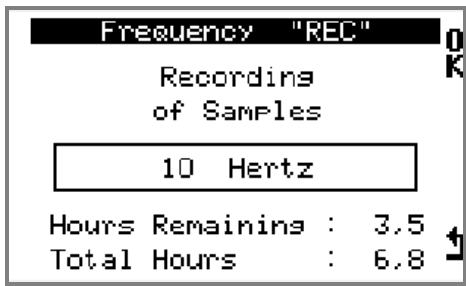

Settle :

- 10 hertz -----> all 100 ms
- 5 hertz -----> all 200 ms
- 2 hertz -----> all 500 ms
- 0 hertz -----> None

This last option is useful for endurance races.

Note : observe the remaining duration and the available total time, these will depend on the chosen frequency.



Unit

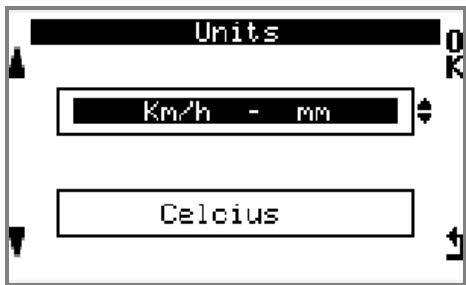

Settle :

- **Imperial** (Mph) or **Metric** (Km/h)
- **Celsius** (°C) or **Fahrenheit** (°F)



Languages



Settle :

- Français
- English
- Italiano
- Deutsch
- Espagnol
- Português



Parameters by default

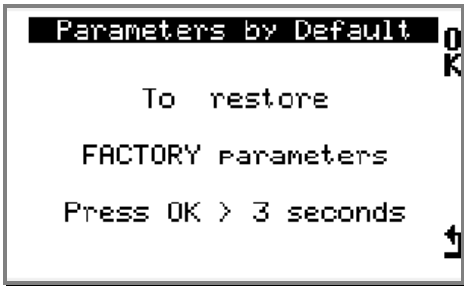

Restore the parameters of factory, press 3 seconds on « OK » to launch the procedure. **Note** : this procedure does not erase tracks and recorded data.



GPS « ON/OFF »



If in some cases, the GPS is not necessary, you can deactivate it. Press on « OK » on icon "GPS ON", then press again 3 seconds on « OK » in the window of confirmation which follows.



To reactivate the GPS module, press on « OK » on icon "GPS OFF", then press again 3 seconds on « OK » in the window of confirmation which follows. **ATTENTION** : The ALFANO switches off automatically, then switch it on to validate the change. **Note** : the consumption of the GPS module decreases the autonomy of the batteries of +/-40 %.



Update

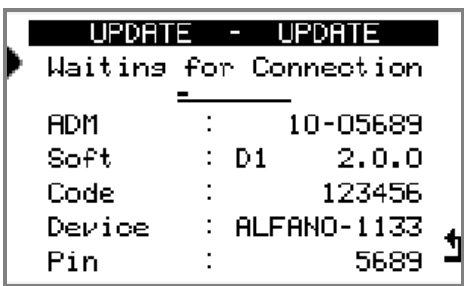

This menu consists in activating Bluetooth to make an UPDATE of the system. All the necessary codes are displayed to synchronize to the computer. **ATTENTION** : Some computers allow with difficulty a connection Bluetooth, in this case, it's better to use the USB-Bluetooth key supplied with the ALFANO. (See details on chapter Update).

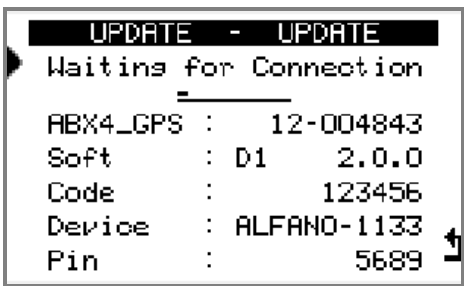

Check the serial numbers of the display and the box. (Press on arrow to vary the display of these numbers).

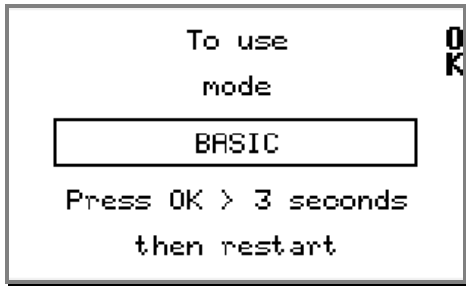

3 seconds pressure on « **OK** » in this window of confirmation to reach the **BASIC** way of working. See chapter, « BASIC mode, page 37 ». ATTENTION : the ALFANO switches off automatically after doing a data erasing, then switch it on again to validate the change.

Tracks management



« Choose »

Select an existing track.

« New »

Create a new track.

« Modify »

Modify the name and the time of “obscurity” of an existing track.

« Delete »

Delete an existing track.

« Send »

Send an existing track via Bluetooth towards another M4/M4GPS/M10.

« Receive »

Receive, via Bluetooth, a track coming from another M4/M4GPS/M10.

Information

For the visualization and the logical recording of the data, it is necessary, before using the ALFANO in race, to configure the morphology of the track. This menu consists in creating tracks (80 maximum) and saving them.

The different technologies of timing

The tracks in Magnetic

This is the most precise solution. The magnetic energy to activate the ALFANO is supplied by Magnetic strips specially created by ALFANO company, this system is patented (E.P.0632350), most of the tracks throughout the world are equipped from 1 to 3 strips.

The tracks in Infrared

The system in Infrared to activate the ALFANO is constituted by a transmitter (ref. A4100) and of a receiver (ref. A140*) with codified frequency, developed by ALFANO company. The transmitter settles down at the edge of the track and the receiver links with the ALFANO instead of the magnetic sensor.

Note : Several transmitters can settle down at the edge of the track to obtain lap's partial times.

The tracks in GPS

The timing data are supplied by the GPS.

The tracks in Magnetic or Infrared + GPS

It is possible to combine two technologies to obtain additional partial times. **Note** : in this case, the magnetic strip or the infrared transmitter is the only reference for the departure and consequently, for the laps' timing.

A) Creation of a track with magnetic strip or with infrared transmitter



« Name of track »

Edit the name of track (Maximum 11 characters, 26 letters of the alphabet, the figures and the space). Use left arrows to modify the character then press on «OK», you have to browse 11 compartments to end.

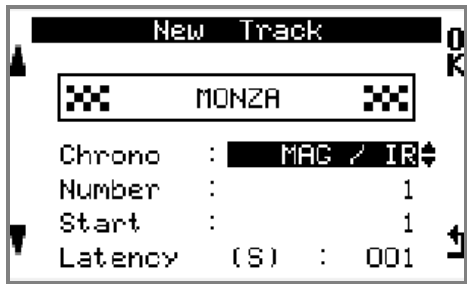

« Method of timing ».

In « Chrono », choose « MAG/IR », then press on «OK».

Note : the GPS remains active on the M4GPS to memorize the trajectory and the speed.



« Number of partials »

In « Number », choose the number of magnetic strips or the number of infrared transmitters installed on the track, then press on «OK».

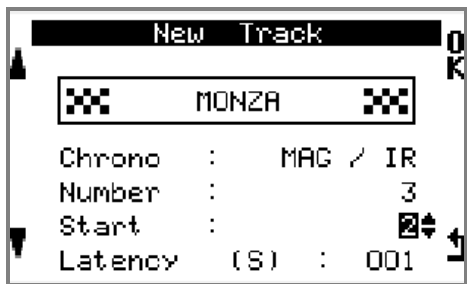

« Partial of departure »

On « Start », choose the magnetic strip or the infrared transmitter wished for the starting up of the timing, then press on «OK».

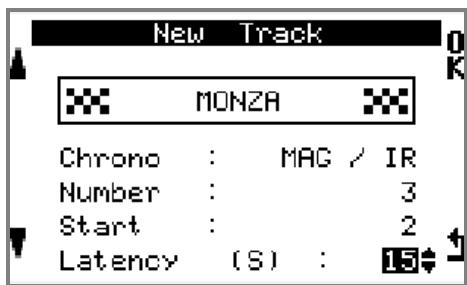

« Obscurity »

In « Obscurity », choose the time (in second) of inactivity of the magnetic sensor or the infrared receiver. After having received the impulse of the magnetic strip or the infrared transmitter, this option allows to ignore during a scheduled lapse of time, the following ones. **Note** : this time, consequently, must be lower than the time to browse the lap. Finally, press on «OK» to finalize and register the track.





IMPORTANT :

With a track created in Magnetic or in Infrared, the GPS of the M4GPS remains active to memorize the trajectory and the speed. With GPS, it is thus not necessary to create a track to obtain these data.

B) Creation of a track GPS coordinates (M4GPS)

IMPORTANT : the configuration of a GPS track is made at the time of its creation, that is to say after having edited the name and having chosen the GPS option, you have to drive immediately on the track to end the procedure.

Procedure to create a GPS track :

| | |
|---|--|
|  | <p>« Name of track » Edit the name of track (maximum 11 characters, 26 letters of the alphabet, the figures and the space). Use left arrows to modify the character then press on «OK», it is necessary to browse 11 compartments to end.</p> |
|  | <p>« Method of timing » In « Chrono », choose « GPS », then press on «OK» to begin the recording of the GPS coordinates.</p> |
|  | <p>« In case of absence of GPS signal » « Wait for GPS signal » appears, in this case, go back to « WELCOME » and wait to get the GPS signals. Note : more there are satellites present, more precise will be the GPS coordinates.</p> |
|  | <p>« To begin the configuration of the track » You have to run to more than 20 kph because the ALFANO also has to memorize the sense of running of the vehicle while recording the GPS coordinates.</p> |

It is possible to record 3 types of tracks

| | |
|---|---|
| 1 | • Start : GPS |
| 2 | • Start : GPS • Partial nr 2 : GPS |
| 3 | • Start : GPS • Partial nr 2 : GPS • Partial nr 3 : GPS |

On the following example : simulation of the 3rd method



This window appears as soon as the vehicle exceeds **20 kph**.



START

Press on «GPS» at the moment wished on the track to memorize the GPS starting point.



PARTIALS

Press on «GPS» at the moment wished on the track to memorize the **GPS** point of partial nr 2.



PARTIELS

Press on «GPS» at the moment wished on the track to memorize the **GPS** point of partial nr 3.

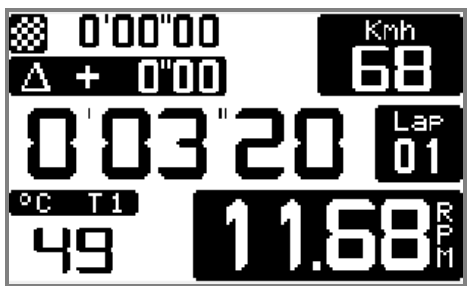

ARRIVAL

Go back on the «GPS» starting point to end the programming of the track and immediately the system starts a session.

ATTENTION : The captures of GPS partials have to be done before going back on the GPS starting point.

C) Creation of a track with Magnetic or Infrared + GPS (M4GPS)

Note : the combination MAG/IR+GPS is possible if the track possesses one or two magnetic strips, because the GPS, in this case, will be only used to fill the number of partial(s) missing.

Example :

- if the track has 1 magnetic strip, the ALFANO can add 2 partials in GPS.
- if the track has 2 magnetic strips, the ALFANO can add 1 partial in GPS.

In this mode of creation MAG/IR+GPS, the programming of the START will be only possible on the magnetic strip or the infrared transmitter and it will be absolutely necessary to memorize at least 1 GPS point to end correctly the recording of the track. If not, the ALFANO initializes the first window to begin again the programming by browsing the following lap.

IMPORTANT : the configuration of a GPS track is made at the time of its creation, that is to say after having edited the name and having chosen the GPS option, you have to drive immediately on the track to end the procedure.

Procedure to create a track MAG/IR+GPS :



« Name of track »

Edit the name of track (maximum 11 characters, 26 letters of the alphabet, the figures and the space). Use left arrows to modify the character then press on «OK», it is necessary to browse 11 compartments to end.

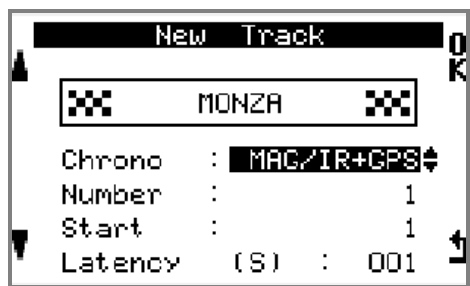

« Method of timing »

In « Chrono », choose «MAG/IR+GPS», then press on «OK».



« In case of absence of GPS signal »

« Wait for GPS signal » appears, in this case, go back to window « WELCOME » and wait to get GPS signals.

Note : more there are satellites present, more precise will be the GPS coordinates.



« Number of partial »

In « Number », choose the number of magnetic strips or of infrared transmitters installed on the track, then press on «OK».



« **Partial of start** »

In « **Start** », choose the magnetic strip or the infrared transmitter wished for the timing starting, then press on «**OK**».



« **Obscurity** »

In « **Obscurity** », choose the time (in second) of inactivity of the magnetic sensor or the infrared receiver. After having received the impulse of the magnetic strip or the infrared transmitter, this option allows to ignore during a scheduled lapse of time, the following ones.

Note : this time, consequently, must be lower than the time to browse the lap. Finally, press on «**OK**» to finalize and register the track.



« **To begin the configuration of the track** »

You have to run to more than **20 kph** because the ALFANO also has to memorize the sense of running of the vehicle while recording the GPS coordinates.

It is possible to record 4 types of tracks :

| | |
|---|--|
| 1 | <ul style="list-style-type: none"> • Start : Mag/IR (Indispensable) • Partial nr 2 : GPS |
|---|--|

| | |
|---|--|
| 2 | <ul style="list-style-type: none"> • Start : Mag/IR (Indispensable) • Partial nr 2 : GPS • Partial nr 3 : GPS |
|---|--|

| | |
|---|---|
| 3 | <ul style="list-style-type: none"> • Start : Mag/IR (Indispensable) • Partial nr 2 : Mag/IR • Partial nr 3 : GPS |
|---|---|

| | |
|---|---|
| 4 | <ul style="list-style-type: none"> • Start : Mag/IR (Indispensable) • Partial nr2 : GPS • Partial nr3 : Mag/IR |
|---|---|

In the following example : simulation of the 3rd method



This window appears as soon as the vehicle exceeds **20 kph**. The icon « **GPS** » is not active, because the ALFANO has to get first and foremost the magnetic strip.



START

Pass on the magnetic strip of the starting to launch the stopwatch. The icon « **GPS** » becomes active, At this moment, it is possible to record a partial with the **GPS**.



PARTIAL nr 2

Pass on the second magnetic strip to memorize the partial nr 2. "MAG" becomes grey while « **GPS** » is still active.



PARTIAL nr 3

Press on «**GPS**» at the moment wished on the track to memorize the partial nr 3, before going back on the magnetic strip of the starting, « **GPS** » becomes again not active.

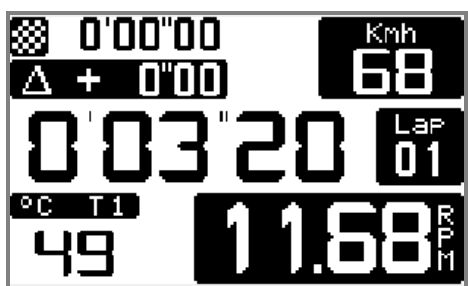

ARRIVAL

Go back on the magnetic strip starting point to end the programming of the track and immediately the system starts a session.

On the following example : simulation of the 4th method



This window appears as soon as the vehicle exceeds **20 kph**. The icon « **GPS** » is not active, because the ALFANO has to get first and foremost the magnetic strip.



START

Pass on the magnetic strip of starting to launch the stopwatch. « **GPS** » becomes active, at this moment, it is possible to record a partial with the GPS.



PARTIAL nr 2

Press on «**GPS**» at the moment wished on the track to memorize the point of **GPS** of the partial nr 2, before passing on the second magnetic strip. « **GPS** » becomes non active again.



PARTIAL nr 3

Pass on the second magnetic strip to memorize the partial nr 3.

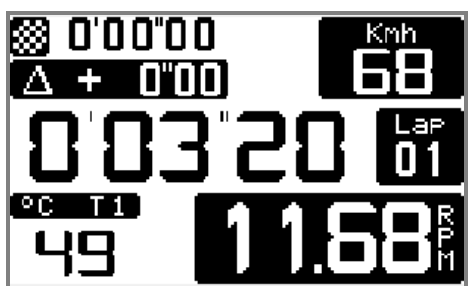

ARRIVAL

Go back on the magnetic strip starting point to end the programming of the track and immediately the system starts a session.

Import tracks from another ALFANO, via Bluetooth

Procedure :

**« ALFANO-1133 »
send the track**

1



Press « **OK** » on « **Send** » on the menu tracks. The ALFANO is searching for the peripheral.

**« ALFANO-2055 »
receive the track**

2



Press « **OK** » on « **Receive** » on the menu tracks. The ALFANO is waiting for a connexion.

3

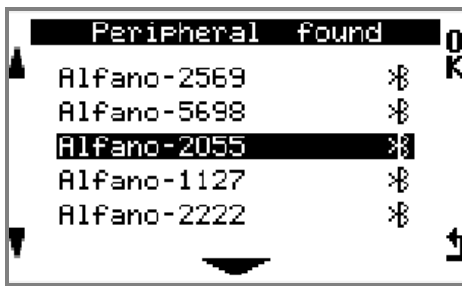

The ALFANO has found several other ALFANO, press « **OK** » on peripheral **2055** to ask for a connexion.

4



Press on « **OK** » to accept the connexion.

5



Choose the track among those recorded in its memory and validate with « **OK** ».

6



The name of the track to receive appears, press on « **OK** » to accept the track.

7



Transfert Réussi.

Note :

Tracks transferred between devices by Bluetooth are identified by a small icon

Starting a timing session and using your device on race

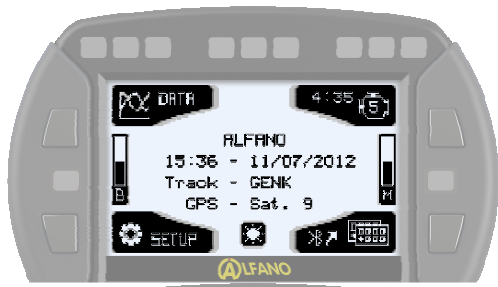

The ALFANO has to be on « WELCOME » page with the adequate track.

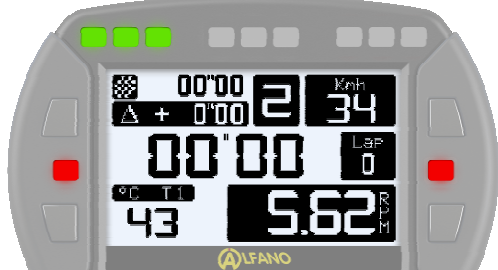

Start the engine and run. In presence of RPM, the windows of racing « Layout » replace the « WELCOME » page, and the values of sensors are displayed on real time.

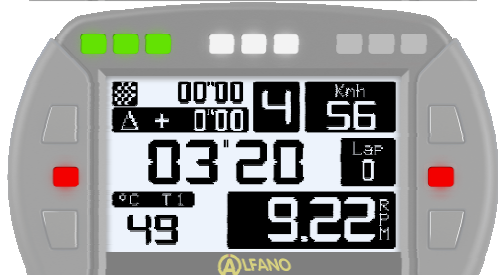

From the detection of the magnetic strip or the GPS starting point, the ALFANO begins the timing and records the data of all these sensors.

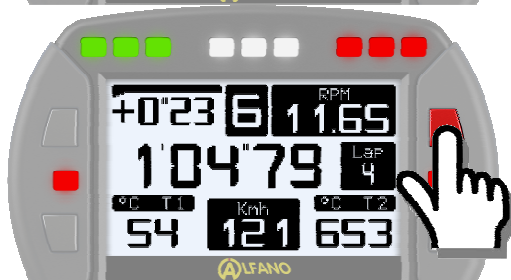

Press on up-right button, to change the « Layout »

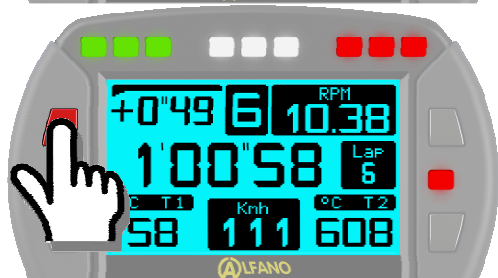

Press on up-left button, it is possible to activate or de-activate the backlight.

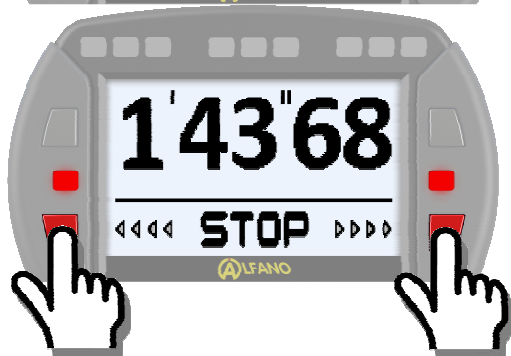

10 seconds after engine switching off, STOP displays, then press on one of the 2 buttons below.

DATA (Menu)

On « WELCOME », press on button 1 « DATA » :



« BEST LAPS »

This window shows during 5 seconds, the best time **Absolute** among all sessions and the best time of the **Last SESSION**, then goes back to « WELCOME ». Press on «OK» in this window to display the menu of data analysis. See below.

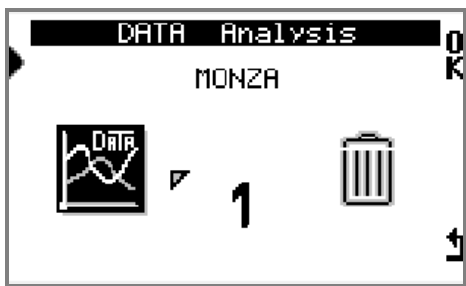

« The recorded data »

In « DATA », you find all the data recorded on the track which is shown in the center of the window, by default, it is the latest used track. Press on « OK » to analyze the data.

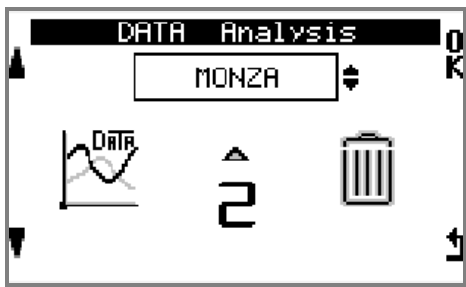

« The used tracks »

Tracks with recorded data will be visible in this scrolling menu. Press on « OK » to open the list, use left arrows to choose, press on « OK » to confirm.

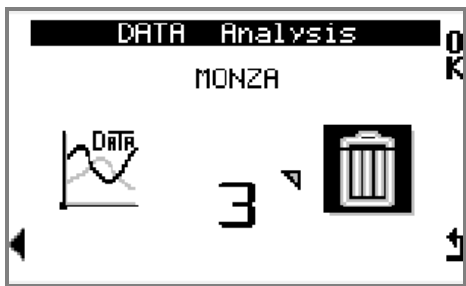

« Total erase of the data ».

Press on « OK », then press again 3 seconds on « OK » in the window of confirmation that follows. **Note** : this command executes the total erase of the data recorded on all the tracks.

DATA

Press « **OK** » on icon DATA :

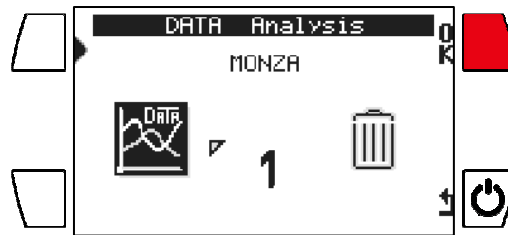

| Date | Hour | B.Lap |
|-----------------|-------|---------|
| BEST LAPS | | |
| THEORETICAL LAP | | |
| 30/04 | 11h56 | 2'14"59 |
| 1 30/04 | 9h25 | 2'18"02 |
| 4 29/04 | 12h43 | 2'14"48 |
| 3 29/04 | 11h52 | 2'15"52 |

Access :

« **BEST LAPS** »
 « **THEORETICAL LAP** »
 « **SESSIONS** »

- « **Best Laps** » and « **Theoretical Lap** » are calculated on all the **Sessions**.
- The « **Sessions** » are listed by date and time.
- The last **Session** is selected by default.

BEST LAPS (on all the sessions)

Press « **OK** » on « **BEST LAPS** », this menu consists in comparing the data of different sensors from the best lap of LAST SESSION and the best lap in ABSOLUTE, press on the double arrow to commute the data of these two laps.

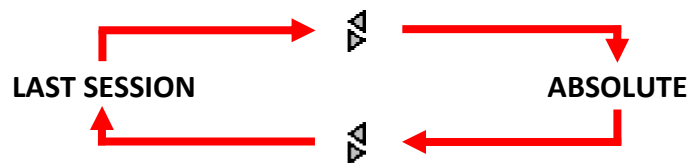

| last Exit | | |
|-----------|---------|----------|
| 11h56 | 1'24"15 | 30-04 |
| RPM ↗ | 14.890 | T1 ↗ 61 |
| RPM ↘ | 6.720 | T1 ↘ 57 |
| ✓ ↗ | 108.3 | T2 ↗ 835 |
| ✓ ↘ | 42.9 | T2 ↘ 523 |

| Absolute | | |
|----------|---------|----------|
| 10h32 | 1'23"54 | 28-04 |
| RPM ↗ | 14.790 | T1 ↗ 63 |
| RPM ↘ | 7.850 | T1 ↘ 58 |
| ✓ ↗ | 110.1 | T2 ↗ 815 |
| ✓ ↘ | 45.2 | T2 ↘ 491 |

| last Exit | | |
|-----------|---------|--------|
| 11h56 | 1'24"15 | 30-04 |
| 06-07 | 1"24 | 1.4 % |
| 07-08 | 10"26 | 12.2 % |
| 08-09 | 15"96 | 18.8 % |
| 09-10 | 10"57 | 12.3 % |

| Absolute | | |
|----------|---------|--------|
| 10h32 | 1'23"54 | 28-04 |
| 06-07 | 0.00 | 0.0 % |
| 07-08 | 2"49 | 2.9 % |
| 08-09 | 12"68 | 14.9 % |
| 09-10 | 19"13 | 22.5 % |

Press the arrow ▼ to show next window, RPM ranges. This option allows to analyze the behavior of the engine through RPM ranges, that is to say the time + the conversion in percentage of this time for all the RPM ranges of 1.000 rotations/min accumulated in this lap. Press on « ▼ » to show the next RPM ranges. Press on double arrow to vary and so compare the data of these two laps. Press on « ↵ » to go back on menu DATA.

THEORETICAL LAP (on all the sessions)

Press « OK » on « THEORETICAL LAP »,

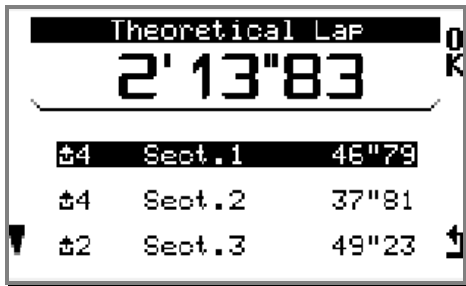

This window takes back the best partials made on all the sessions, and calculates then the theoretical time. Press on « OK » on partial wished to reach the lap belonging to it

SESSIONS

Press « OK » on the wished « SESSION ». The complete analysis of the **SESSION** is made in 4 steps :

Step 1
Best Lap / Theoretical Lap
of the selected SESSION

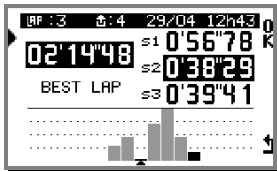

Step 2
The laps
of the selected SESSION

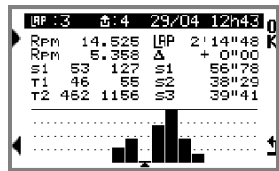

Step 3
RPM ranges
of the selected LAP

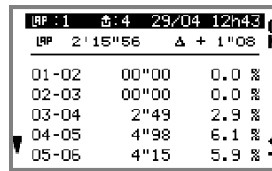

Step 4
Graphic Analysis
of the selected LAP

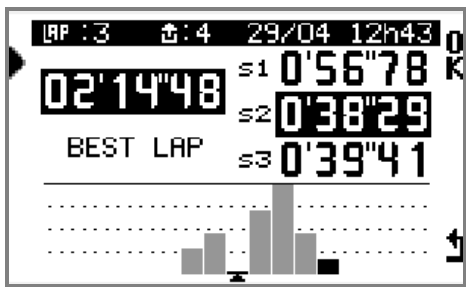
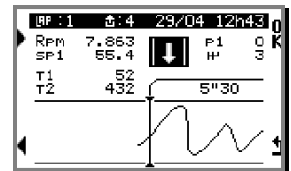

Step 1 « BEST LAP »

The best lap of the SESSION with the best partial(s) on black background.

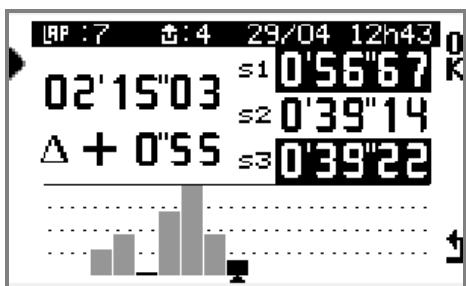

Press on « ▶ » to show the lap with the others best partials.

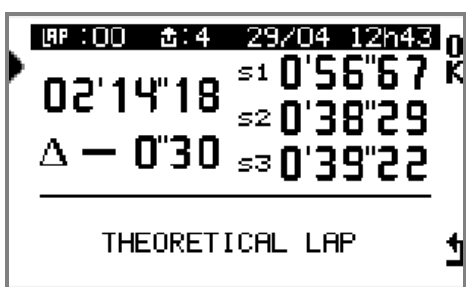

Press again on « ▶ » to show the theoretical lap of the SESSION « THEORETICAL LAP ». Press on « OK » to show the window « step 2 ».

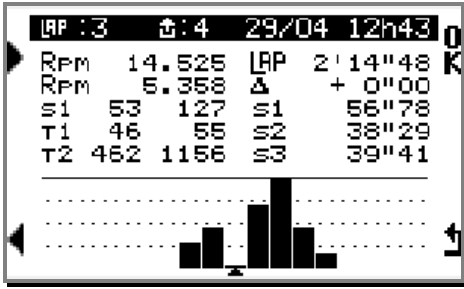

Step 2 « The LAPS » of the SESSION

The cursor positions automatically on the best lap, bars-graphs represent the number of laps and the height indicates the difference of time between every lap. The gap of time between the low level and the top level of bars-graphs is customizable in the menu « SETUP »

Use the arrows ◀▶ to move from a lap to another, a long pressure allows a fast scrolling. Every lap is accompanied with its time and with the gap of time compared with the best lap of the session with its partial times and its Max/Min : **RPM / SPEED / T1 / T2**. Press « OK » on the desired lap to go on with the analysis in « step 3 ».

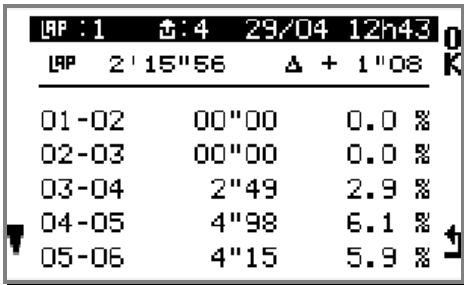

Step 3 « Plages RPM »

This option allows for the lap chosen on (step 2) to analyze the behavior of the engine through RPM ranges, that is to say the time + the conversion in percentage of this time for all the RPM ranges of 1.000 rotations/min accumulated in this lap. Press on « ▼ » to show the next RPM ranges, press on « OK » to show the window « step 4 »

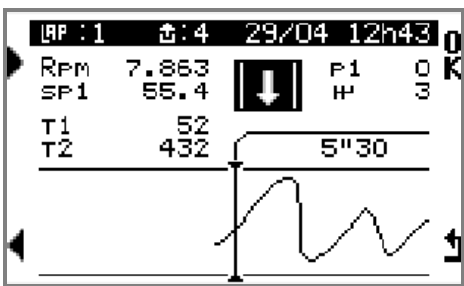
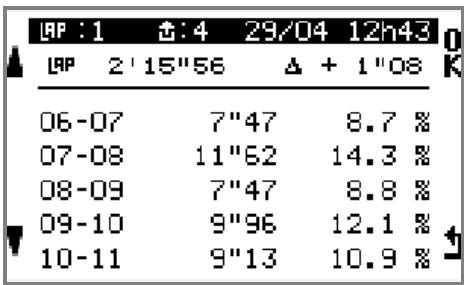

Step 4 « Graphic Analysis »

For an accurate analysis, this option allows to view the chosen lap on (step 2), step by step, according to the frequency (recording chosen on « SETUP » : **RPM (+graphic), SPEED, T°1, T°2**). Use the arrows ◀▶ to browse the lap, a long pressure allows a fast scrolling.

Download

- 1) Launch the software of analysis « VISUALDATA2 » also allowing to get back the data of the ALFANO (see instructions for use of the software).
- 2) Press **1 second** on button 4 to activate the Bluetooth of the ALFANO



A window appears with the necessary information for the synchronization of these two devices. Introduce these data and the configurable personal password in the « SETUP ».

- 3) The command of the transfer is made from the software of analysis.

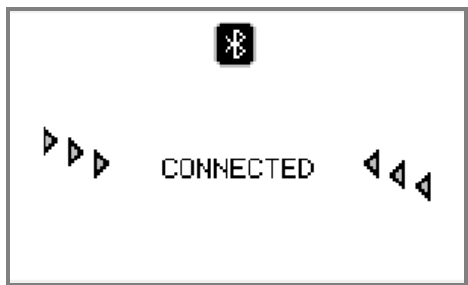

This window confirms the connection with the computer.

The meters of running time

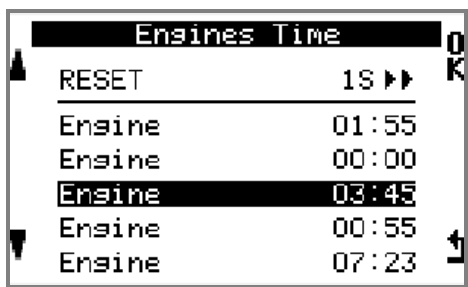

This menu shows the meters of running time of 5 engines :

- A single engine can be active. The chosen engine will be visible on « WELCOME »
- Press on « OK » on the engine selected to activate it.
- Press 1 second on « OK » on the engine selected for the putting with zero.

The windows of racing « Layouts »

In « WELCOME », press on button 4 :



This is a window explaining the buttons' function during the layouts' display, a pressure on one of these buttons and the layouts replace this window.

Press successively on « **Choice** » to visualize the windows of racing (layout). At present, there are not less than 11 windows of racing. Then, it is possible to :

- Press successively on « **Simul** » to simulate manually a timing. This to have an idea of the working on race.
- Press « **Reset** » for the putting with zero of the simulator.



Each « Layout » has a number to make your choice easier. That number with the word « **Confirm** » appears only a few seconds, then press on button « **Confirm** » to choose it, even if the word is not displayed anymore.

The windows of racing

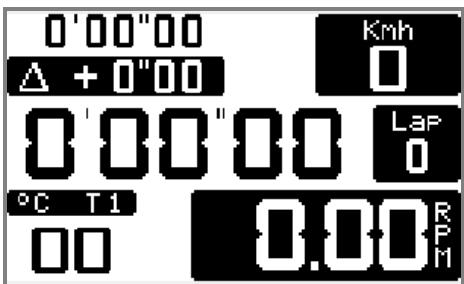

Race « 1 »

- Best time / Lap time / Gap
- Nr of the lap
- Temperature T1
- RPM
- Speed

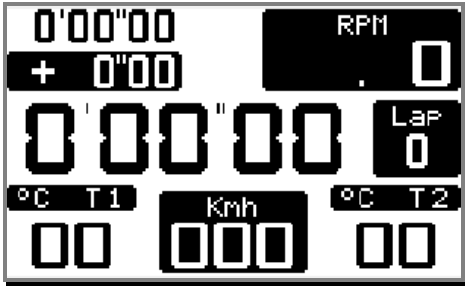

Race « 2 »

- Best time / Lap time / Gap
- Nr of the lap
- Temperature T1 / T2
- RPM
- Speed



Race « 3 »

- Lap time / Partial times/ Gap
- Nr of the lap
- Temperature T1 / T2
- RPM
- Speed

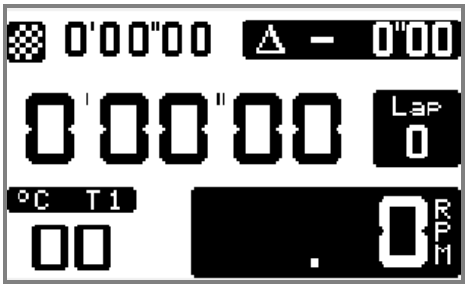

Race « 4 »

- Best time / Lap time / Gap
- Nr of the lap
- Temperature T1
- RPM

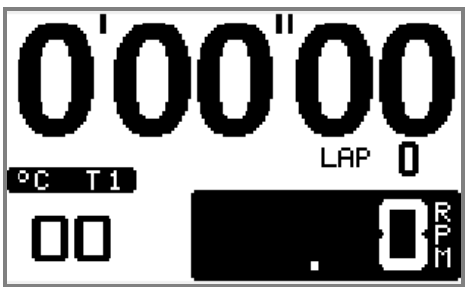

Race « 5 »

- Lap time
- Nr of lap
- Temperature T1
- RPM

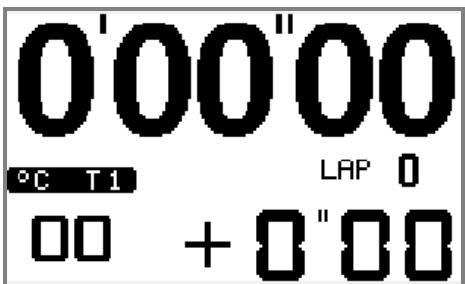

Race « 6 »

- Lap time / Gap
- Nr of lap
- Temperature T1

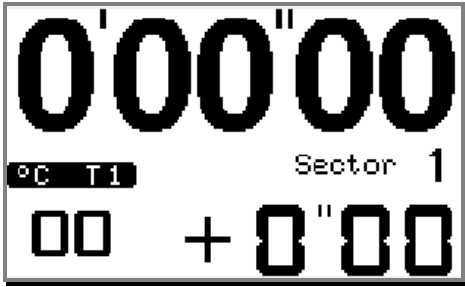

Race « 7 »

- Lap time / Partial times / Gap
- Nr of lap
- Temperature T1

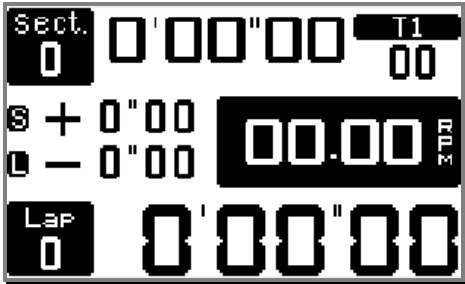

Race « 8 »

- Lap time / Partial times/ Gap
- Nr of lap / Nr of partial
- Temperature T1
- RPM



Race « 9 »

- Lap time / Engine time
- Nr of lap
- Nr of engine
- Temperature T1
- RPM



Race « 10 »

- Lap time
- Nr of lap
- Lambda

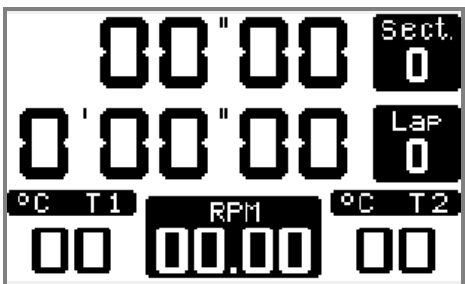

Race « 11 »

- Lap time / Partial times
- Nr of lap / Nr of partial
- Temperature T1 / T2
- RPM

Note : it will be also possible to change the layout while running on the track, with the same button.
Other layouts will be available in the future.

« BASIC » mode (simplified working)

This mode takes back the most essential elements of working for a very simplified use.

To pass of **FULL** mode in **BASIC** mode : in the menu SETUP, press « **OK** » on icon «  », press again 3 seconds on « **OK** » in the window of confirmation that follows. **ATTENTION** : the activation of the **BASIC** mode erases the data recorded previously. On the other hand, the parameters of setting, the tracks and the names of the pilots will not be deleted. **Note** : the ALFANO has to pass by the extinction and the re-start to consider this mode.

- DATA
- Erase DATA

(Button 1)

Number satellites got
(M4GPS)



Witness backlight activated

- Track Configuration

(Button 2)

(Button 3)

Setup :

- RPM
- Temperature
- Display
- Units
- Back to BASIC mode

Capacity state of batteries

Capacity of available memory

(Button 4)

- Switch on
- Bluetooth Activation
- Access FULL mode
- Switch off

« Button 4 »

Switch on : press on button 4 on right below.



Switch off : on « WELCOME », press on the same button.

Backlight : the way of working is the same as in FULL mode. See page 9.

Bluetooth Activation : on « WELCOME », press **1 second** on button 4

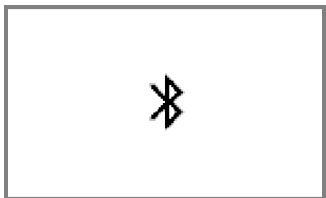

The icon **Bluetooth** appears during 2 seconds before showing the window below.



The name of the peripheral and the PIN code / key of access display, it allows then to communicate with your computer to download your data.

Button 1 « DATA » : « Data erasing »

On « WELCOME », press on button 1 « DATA »



- **DATA** : this menu takes back the analyses of the FULL mode:
 - « **BEST LAPS** » (page 30)
 - « **THEORETICAL LAP** » (page 31)
 - « **THE SESSIONS** » step 1 to step 2 (page 31)
- **To erase the data** :
 - (following DATA), in the window step 2 « SESSION », press on « **OK** », then press again 3 seconds on « **OK** » in the window of confirmation that follows.
- Press on «  » to go back on « WELCOME ».

Button 3 « TRACKS »

On « WELCOME », press on button 3 « TRACK »



Note : in the BASIC way of working, the track is created at every change of morphology of this one and the former data are systematically erased.

A) Create a track Magnetic/Infrared

After having pressed on button 3, icon « TRACK » on « WELCOME »,

- With the arrow « ▶ » of the top, choose the number of magnetic strip(s) or the number of transmitter(s) installed on the circuit.
- With the arrow « ▶ » in the bottom, choose on which magnetic strip or which infrared transmitter the device has to start.
- Press on « OK » to end the configuration of the track.

In the following example : configuration of a track with 3 magnetic strips with the starting of the timing on the 2nd magnetic strip.

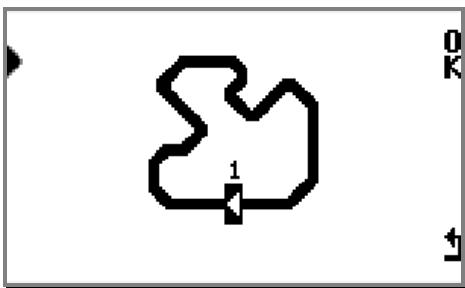

This figure represents a track with a single magnetic strip.

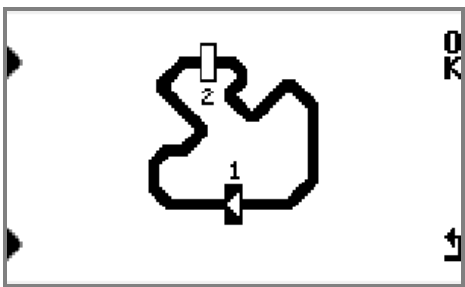

Press on arrow ▶ of the top to add a second magnetic strip.

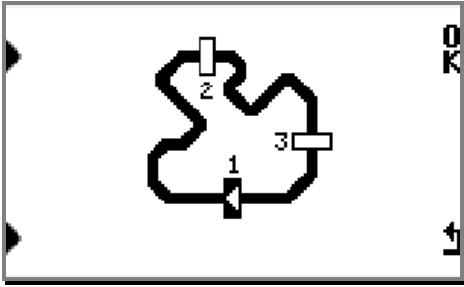

Press on arrow ► of the top to add a third magnetic strip.

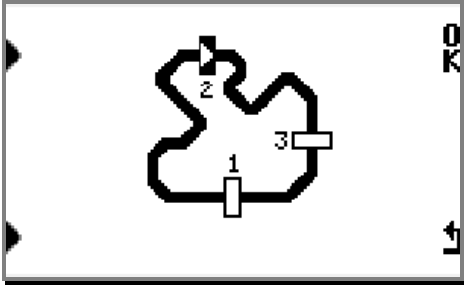

Press on arrow ► in the bottom to choose the starting up of the timing on the 2nd magnetic strip, then press on « **OK** » to end the configuration of the track. **Note** : this track will be kept in memory until the next change of its morphology.

B) Create a GPS track with the « M4GPS »

It is possible to program 3 types of tracks

| | | |
|----------|------------------|-----|
| 1 | • Start : | GPS |
| 2 | • Start : | GPS |
| | • Partial nr 2 : | GPS |
| 3 | • Start : | GPS |
| | • Partial nr 2 : | GPS |
| | • Partial nr 3 : | GPS |

IMPORTANT : the configuration of a GPS track is made at the time of its creation, that is to say after having edited the name and having chosen the GPS option, you have to drive immediately on the track to end the procedure.

Procedure to create a GPS track :

Note : in the M4GPS, the menu « TRACK » goes on, press successively on arrow ► of the top, until obtain the window « **GPS** » below.



Press on « **OK** » to start the recording of GPS coordinates on the track.



You have to run to more than **20 kph** because the ALFANO also has to memorize the sense of running of the vehicle while recording the GPS coordinates.

The creation of a GPS track is made in the same way as in the FULL mode (see page 21)

Button 2 « SETUP »

On « WELCOME », press on the button 2 « SETUP »

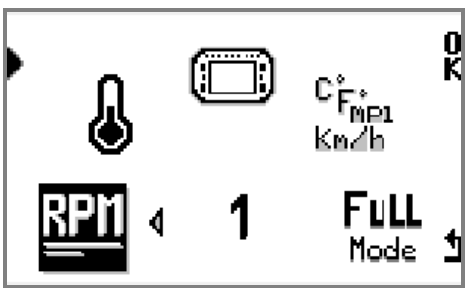

Configure :

- The RPM
- The Temperature
- Display
- The Units
- Back to FULL mode

Press « OK » on wished menu to configure it.

Press on « ↵ » to go back on « WELCOME ».

RPM

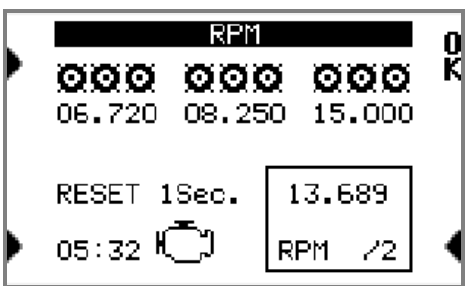

- Press on arrow on the top left to configure the 3 RPM thresholds with the 9 leds, in groups of 3.
- Press 1 second on the arrow of bottom left for the putting with zero of the running meter. **Note :** a single meter is available on the BASIC mode.
- Press successively on bottom right arrow to settle the coefficient of multiplication, depending on the type of engine : /4, /2, x1, x2, x4.

Press « OK » to go back on « Menu SETUP ».



Temperature

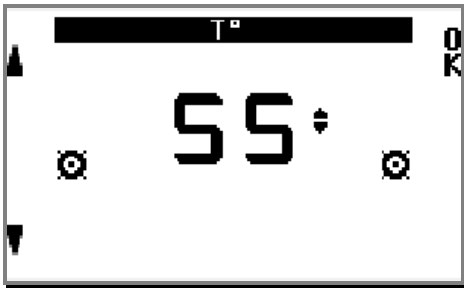

- Settle the threshold of the 2 leds for the Temperature T1.

Press on « **OK** » to go back to « Menu SETUP ».

IMPORTANT : only NTC type sensors are managed by the BASIC mode.



Display

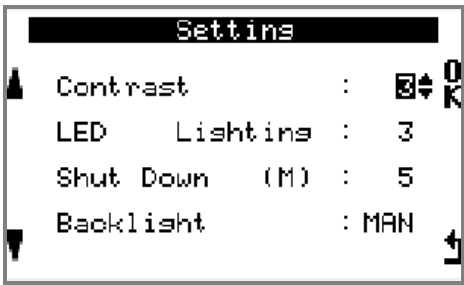

Settle :

- Screen contrast,
- LEDs brightness,
- Time for automatic extinction,
- Backlight :
 - « **OFF** » : the device switches on without.
 - « **MAN** » : the device suggests it.
 - « **1-9** » : the device switches on automatically with (Set its brightness power from 1 to 9).



Unit

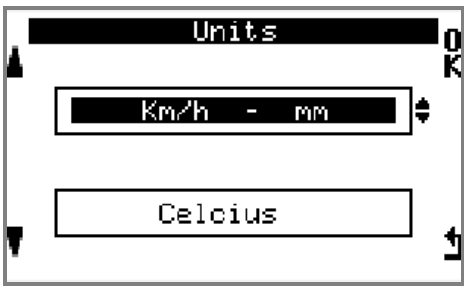

Settle :

- **Imperial** (Mph) or **Metric** (Km/h)
- **Celsius** (°C) or **Fahrenheit** (°F)



Go back to FULL mode

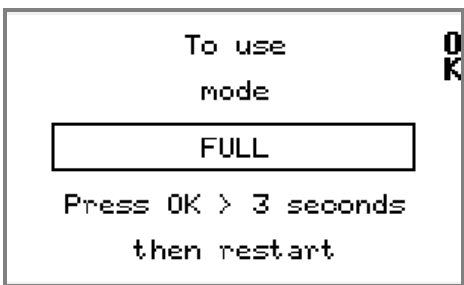

Then press 3 seconds on « **OK** » in the window allowing to go back on FULL mode. **ATTENTION** : the ALFANO switches off automatically after doing a data erasing, then switch it on again to validate the change.

Batteries

A4019

Alkaline PROCELL 1.5V model « AA/R6 »



A4018

Rechargeable UNIROSS, 2050 mAh Hybrio 1.2V



! Without memory effect !

A4016

UNIROSS charger from 100 to 240V 50/60Hz



A4017

ALFANO Rechargeable Pack 8.800 mAh Li Ion 3.7V (Waterproof) 75x40x40mm
Delivered with a 100 to 240V 50/60Hz charger and a case



Systems



A4004 (A4012 + A4001)

Power supply for M4/M4GPS through the 12V vehicle's battery

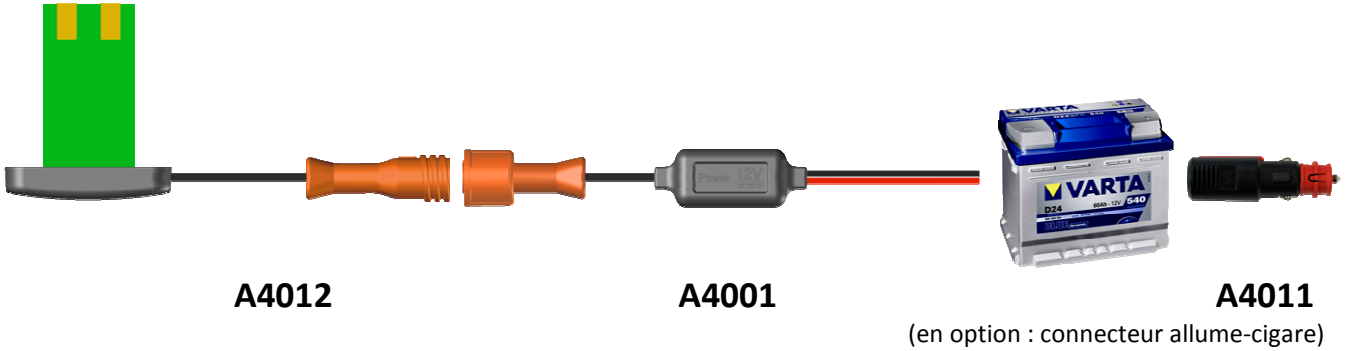

A4005 (A4013 + A4017)

Power supply for M4/M4GPS through ALFANO Li-ion 3.7V rechargeable pack



Board of Consumptions

| | Alkaline | UNIROSS | Bloc ALFANO Li Ion 3.7V |
|----------------|----------|---------|----------------------------|
| M4 * | 5h | 8h30 | 52h |
| M4 | 9h | 15h30 | 93h |
| M4GPS * | 3h | 5h30 | 31h30 |
| M4GPS | 5h50 | 9h30 | 56h30 |

* with backlight on (power 5)

Board supplied for information purposes only

VisualData2

Download our software VISUALDATA2 (Windows) available on www.alfano.com

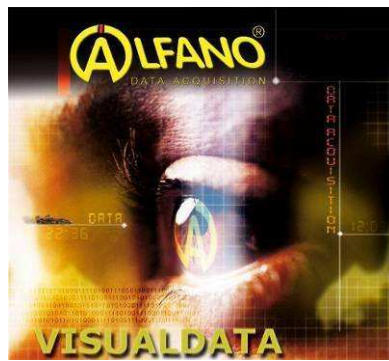

Start the “executable” from your computer and follow the instructions of the VISUALDATA2 manual of installation also available on our website www.alfano.com

Update FIRMWARE

The menu update allows to make the update of your M4/M4GPS. The updates allow to correct possible problems but also to improve the M4/M4GPS. Use a computer with integrated Bluetooth peripheral or the supplied USB / Bluetooth key.

Enter the menu Update via the menu Setup.

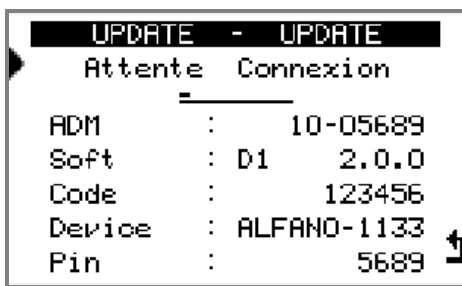

Download the « executable » FIRMWARE available on our website www.alfano.com
New updates will be continuous available.

Start the “executable” from your computer and follow the instructions of the FIRMWARE installation manual also available on our site www.alfano.com

ATTENTION : During the update, do not remove the batteries
Do not interrupt the BUS connection between thebox and the
display

Various

A message appears when your batteries are low. Check your batteries' life in the « WELCOME » window before beginning the recordings in race.

Memory

Also think of checking the available memory with memory space in the « WELCOME » window or the time remaining on the setup menu --- > REC. not to saturate the memory when you run.

You can record a maximum of 99 sessions by track.

You can record a maximum of 327 sessions on all the tracks.

You can record a maximum of 99 laps by closed track session, if you run more laps, a new session will start automatically.

The maximum time is 1 hour by lap.

GPS

GPS Signal

On switching on your M4GPS, it will wait for the GPS signal. The waiting time and the reception depends on several parameters:

The environment in which the M4GPS is (high rise, forest, clear sky, etc...)

The Cold Start or Warm Start : the M4GPS receives the signal faster when it is regularly used, indeed, the more the GPS remains faded for a long time, the longer the waiting time before getting the signal will be next time you start it. This waiting time can thus vary from a few seconds to several minutes.

Number of Satellites

The GPS gets its real position from 3 satellites. The maximal number of satellites which we can get is 12 (it is possible only at certain hours of the day because satellites are constantly in movement). More satellites mean better precision with the GPS positioning, and therefore more precise timing. We recommend 8 satellites at least, the precision of time cannot be guaranteed with any less.

Date & hour

As indicated in the menu Setup, the satellite gives us the hour and the date GMT, that is why it is necessary to adjust the time zone accordingly in the menu Setup >Set upHour/Date.

Warranty conditions

All our devices have been subject to in-depth factory tests and are covered by a 24-month warranty against manufacturing defects. The warranty comes into action from the date of purchase. The date of purchase is the date stated on the invoice/receipt given by the seller at the time of sale. The manufacturer undertakes to repair and replace free of charge any parts which have a manufacturing defect during the warranty period. Any defects which cannot be clearly attributed to the material or the manufacturer will be examined at one of our approved after-sales service centers and invoiced depending on the results. The warranty does not apply in cases of device opening, accidental damage, negligence or misuse, inappropriate or incorrect installation or failure to perform the installation in accordance with the instructions contained in the attention note and in events not associated with the rules of operation and use of the device. The warranty will become null and void in cases of repair or handling carried out by unauthorized third parties. Intervention under warranty does not entitle to the device replacement or warranty extension. Intervention under warranty is carried out at one of our approved after-sales service centers or at our head office. In the latter case, the item must reach our establishment postage paid, that is, transport costs shall be paid by the user. The manufacturer undertakes no responsibility for any damage to persons or goods caused by poor installation or incorrect use of the device.

Product modifications

Alfano SA applies a method of continuous development. **Alfano SA** reserves the right to make changes and improvements to any product described in this document without prior notice. No modifications or changes to the product should be done without **ALFANO SA** approval.

Damages and responsibilities

The products are used under the customer's sole discretion and risk and therefore damages suffered or caused by the products shall be the customer's responsibility. **ALFANO SA** cannot be held responsible for the direct or indirect consequences of wrong use.

Disposal

The device must be disposed with respect for the environment. The chronometer and its accessories contain many plastic parts. When the chronometer or one of its accessories no longer functions, they must be dealt in accordance to the laws of the Country where it is located. Used batteries must be disposed in accordance with the Country's environmental regulations.



Rue de l'Industrie, 3b – 1400 NIVELLES (BELGIUM)

www.alfano.com